

# FLOOD RISK ASSESSMENT

Regional Biosolids Storage Facility - EIAR Addendum

IE000258  
24 July 2023  
IE000258RP0006

Page left intentionally blank

## Contents

<b>1</b>	<b>INTRODUCTION</b> .....	<b>1</b>
1.1	Terms of Reference and Scope .....	1
1.2	Flood Risk Assessment; Aims and Objectives.....	1
<b>2</b>	<b>BACKGROUND</b> .....	<b>2</b>
2.1	Site Location .....	2
2.2	Proposed Development.....	2
<b>3</b>	<b>EXISTING SITE CHARACTERISTICS</b> .....	<b>4</b>
3.1	Hydrology & Drainage .....	4
3.2	Topography .....	5
3.3	Geology .....	6
<b>4</b>	<b>FLOOD RISK IDENTIFICATION – STAGE 1</b> .....	<b>7</b>
4.1	Flooding History .....	7
4.1.1	OPW Flood Hazard Mapping .....	7
4.1.2	Anecdotal Evidence .....	8
4.1.3	GSI Historical Groundwater Flooding .....	8
4.2	Predictive Flood Risk Mapping .....	8
4.2.1	CFRAM Preliminary Flood Risk Assessment (PFRA) Maps .....	8
4.2.2	Fingal County Strategic Flood Risk Assessment (SFRA) 2023-2029 .....	8
4.2.3	Fluvial Flooding.....	9
4.2.4	Pluvial Flooding.....	10
4.2.5	Coastal Flooding.....	10
4.2.6	Groundwater Flooding .....	10
4.3	Stage 1 Conclusion .....	11
<b>5</b>	<b>INITIAL FLOOD RISK ASSESSMENT – STAGE 2</b> .....	<b>12</b>
5.1	Mitigation Measures .....	12
5.1.1	Proposed Surface Water Infrastructure .....	12
5.2	Stage 2 Conclusion .....	13
<b>6</b>	<b>CONCLUSION</b> .....	<b>14</b>

## Tables

Table 4-1: Summary of Flood Risk Identification.....11

## Figures

Figure 2-1: Location of Proposed Development (annotation by J.B. Barry & Partners).....2  
Figure 2-2: Indicative layout of the proposed Regional Biosolids Storage Facility .....3  
Figure 3-1: Hydrological features of area .....4  
Figure 3-2: Topography of Proposed Development Site .....5  
Figure 3-3: GSI Teagasc Soil mapping (www.gsi.ie).....6  
Figure 4-1: Locations of historic flooding (www.floodinfo.ie) .....7  
Figure 4-2: Extract of the PFRA map (www.cfram.ie annotation by J.B. Barry & Partners) .....8  
Figure 4-3: Extract from Fingal County SFRA Flood Zone map - Current Scenario .....9  
Figure 4-4: Excel Calculations .....10  
Figure 5-1: Surface Water Catchments (Engineering Design Report) .....12

## Appendices

Appendix A The Planning System and Flood Risk Management.....15  
Appendix B OPW Summary Local Area Reports .....18  
Appendix C PRFA Map.....19  
Appendix D Fingal CC SFRA Flood Zone Map .....20  
Appendix E Surface Water Drainage Layout.....21  
Appendix F Catchment Area and Flow Calculations .....22

# 1 INTRODUCTION

Under the Planning System and Flood Risk Management Guidelines for Planning Authorities (DoEHLG & OPW, 2009) the proposed development must undergo a Flood Risk Assessment to ensure sustainable and effective management of flood risk.

## 1.1 Terms of Reference and Scope

RPS Consulting was appointed by Uisce Éireann to prepare a Site-Specific Flood Risk Assessment (FRA) to assess the Proposed Development of a new Regional Biosolids Storage Facility (RBSF) located along the R135 adjacent to the N2 national primary road and within the townland of Newtown. The FRA was undertaken in relation to the Fingal County Council (FCC) County Development Plan 2023-2029 (CDP), including the Strategic Flood Risk Assessment (SFRA), and in accordance with the Planning System and Flood Risk Management Guidelines for Planning Authorities (DoEHLG & OPW, 2009).

A previous FRA Report for the site was carried out by J.B. Barry & Partners on 21/05/2018.

## 1.2 Flood Risk Assessment; Aims and Objectives

This study was completed to update the original Flood Risk Assessment of the proposed development. It aims to identify, quantify, and communicate to Planning Authority officials and other stakeholders the latest risk of flooding to land, property and people and the measures required to manage the risk.

The objectives of this FRA are to:

- Identify potential sources of flood risk;
- Confirm the level of flood risk and identify key hydraulic features;
- Assess the impact that development has on flood risk;
- Develop appropriate flood risk mitigation and management measures which will allow for the long-term development of the site;
- Review the likely effects of climate change and residual risk.

Conclusions of the assessment are provided in the context of the OPW / DoEHLG planning guidance, "The Planning System and Flood Risk Management".

For general information on flooding, the definition of flood risk, flood zones and other terms see 'Understanding Flood Risk' in **Appendix A**.

## 2 BACKGROUND

### 2.1 Site Location

The Proposed Development Site is located along the R135 adjacent to the N2 national primary road and within the townland of Newtown, as shown in **Figure 2-1**.



**Figure 2-1: Location of Proposed Development (annotation by J.B. Barry & Partners)**

### 2.2 Proposed Development

The Proposed Development consists of the construction 2 no. portal frame warehouses for the storage of biosolids, a by-product of wastewater treatment which can be used on agricultural lands as a soil conditioner. Ancillary works on the site will also include access roads, weighbridges, and administration buildings, as shown in **Figure 2-2**.



Figure 2-2: Indicative layout of the proposed Regional Biosolids Storage Facility

### 3 EXISTING SITE CHARACTERISTICS

#### 3.1 Hydrology & Drainage

The Proposed Development Site is within the Nanny-Delvin catchment. The most notable watercourse in the vicinity of the site is the Huntstown Stream, a tributary to the River Ward, which flows northwest of the site. The Huntstown Stream flows in a northerly direction, is culverted under the N2, and flows to the River Ward approximately 4.5km northeast of the proposed site.

The FRA carried out by J.B. Barry & Partners for the development site identified minor flows flowing along a drainage ditch on the western and southern boundaries of the proposed site. A previous hydrological report<sup>1</sup> carried out by SLR Consulting Ireland referred to this as the Ballystrahan Stream. The Stream is a tributary of the Huntstown Stream, with the confluence located northwest of the proposed site. The watercourses lie within the River Ward Sub Basin in the Broadmeadow sub catchment area.

The site was partially developed in 2009 under a previous planning application. The drainage infrastructure includes an attenuation pond and two outfalls to the Stream, however the design criteria and as-built layout could not be verified or reconciled.

See **Figure 3-1** for the location of the Proposed Development Site relative to surrounding watercourses and waterbodies.



**Figure 3-1: Hydrological features of area**

<sup>1</sup> SLR Consulting Ireland, 2013. Proposed Renewable Bioenergy Plant – Environmental Impact Statement, Chapter 13 Hydrology. [https://epawebapp.epa.ie/licences/lic\\_eDMS/090151b2804f3b67.pdf](https://epawebapp.epa.ie/licences/lic_eDMS/090151b2804f3b67.pdf)



### 3.2 Topography

The Proposed Development Site falls naturally from east to west with its lowest point along the channel on the western boundary of the site, as shown in **Figure 3-2**. The LiDAR data (published 28/08/2018) shown below Contains Irish Public Sector Data (Geological Survey Ireland & Transport Infrastructure Ireland) licensed under a Creative Commons Attribution 4.0 International (CC BY 4.0) licence and has been used in this FRA to investigate the topography.

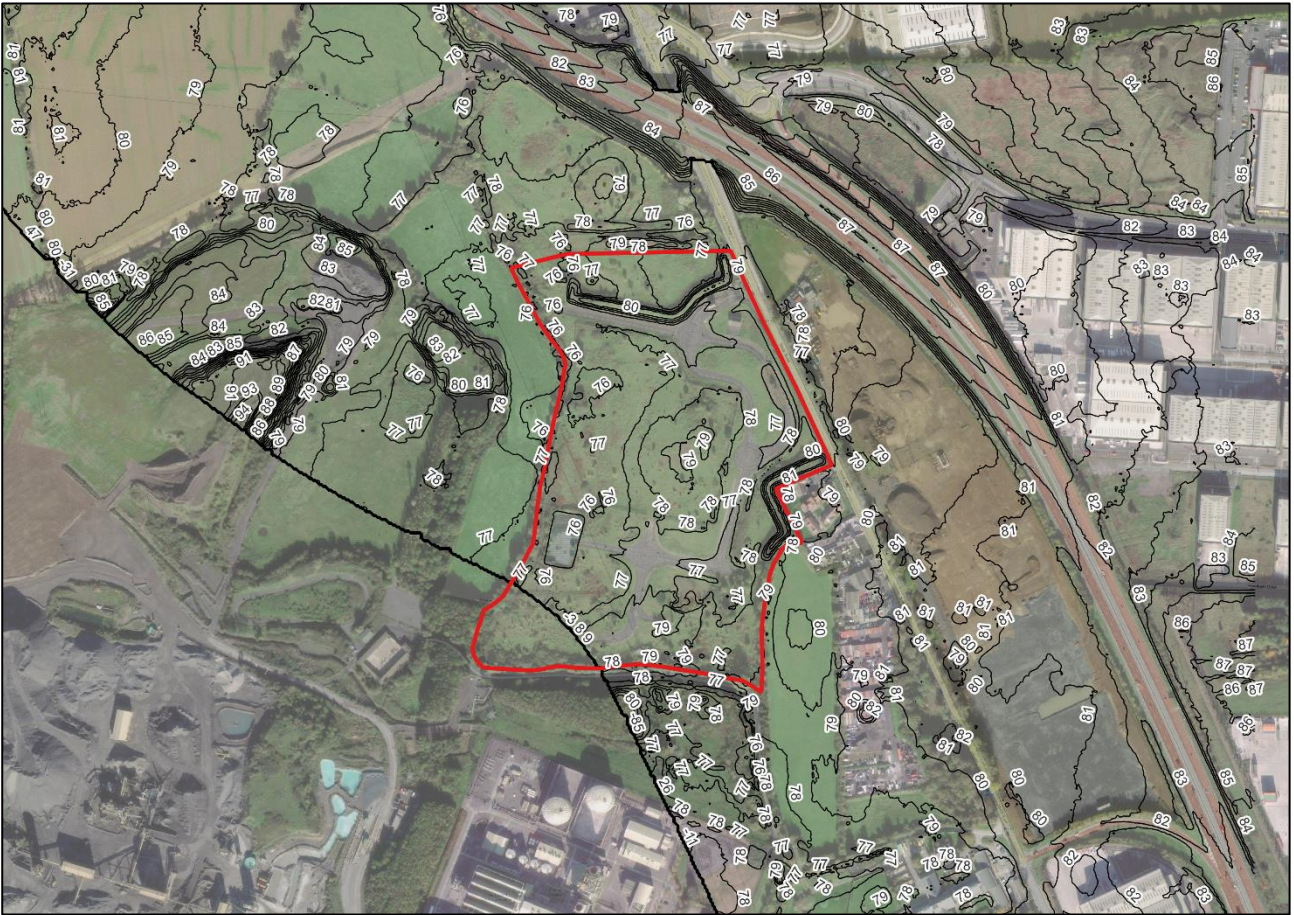

**Figure 3-2: Topography of Proposed Development Site**

### 3.3 Geology

The Geological Survey of Ireland (GSI) website provides information on their public online mapping service at [www.gsi.ie](http://www.gsi.ie) on soil types. The map presented in **Figure 3-3** depicts the subsoil for the proposed development site. The GSI Teagasc soils mapping indicates that tills derived from limestone and made ground are the dominant ground condition within the environs of the development site. There are areas bedrock exposed to the surface adjacent to the Proposed Development Site.

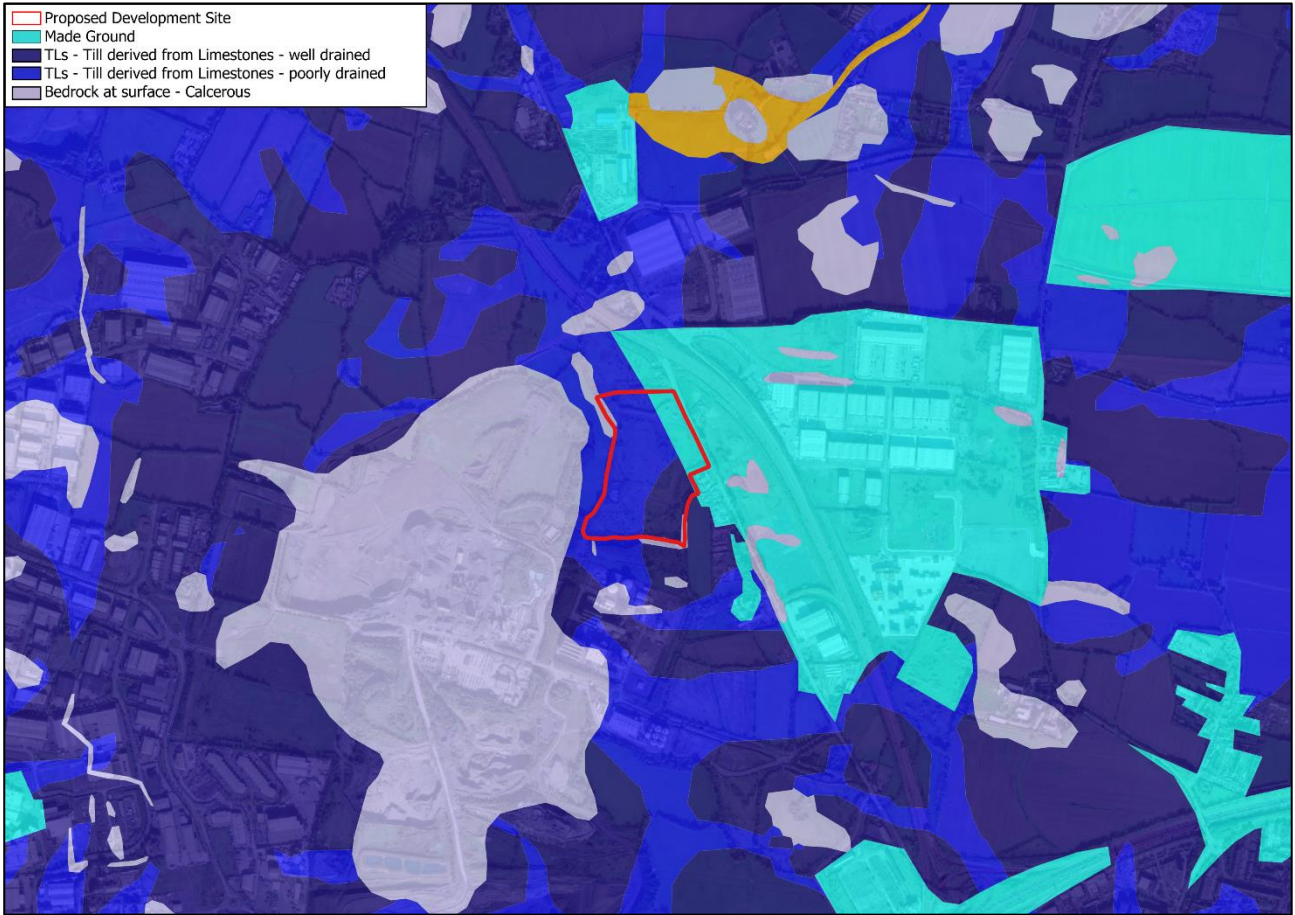

Figure 3-3: GSI Teagasc Soil mapping ([www.gsi.ie](http://www.gsi.ie))

## 4 FLOOD RISK IDENTIFICATION – STAGE 1

This section identifies existing information pertinent to flood risk at the site. The information used to inform this assessment includes historical mapping and indicative sources relating to previous predictive flood studies and risk assessments.

### 4.1 Flooding History

#### 4.1.1 OPW Flood Hazard Mapping

The National Flood Hazard Mapping Website [www.floodmaps.ie](http://www.floodmaps.ie) does not show any records of historic floods occurring at the Proposed Development Site, however it does show two records of flooding within a 2.5km radius of the Proposed Development Site. The flood at Kilshane Cross in November 2002 is within the vicinity of the Proposed Development Site (**Figure 4-1**). A report on the flood prepared by Fingal County Council, identifies that flooding occurred on the N2 at Kilshane Cross as a result of surface water runoff accumulating from adjacent grasslands. A 2005 report from Fingal Co Co has identified that drainage works have taken place to alleviate any flooding issues as part of road development works.

A Summary Local Area Report (SLAR) was generated for the site, which identifies all flooding events, which occurred within a 2.5km radius of the proposed development site (**Appendix B**). The report indicates the site is partially located in Broadmeadow and Ward Arterial Drainage Scheme Benefitted Lands. The Ballystrahan Stream channel is referred to as C2/1 under the Scheme, which was completed between 1961-64.

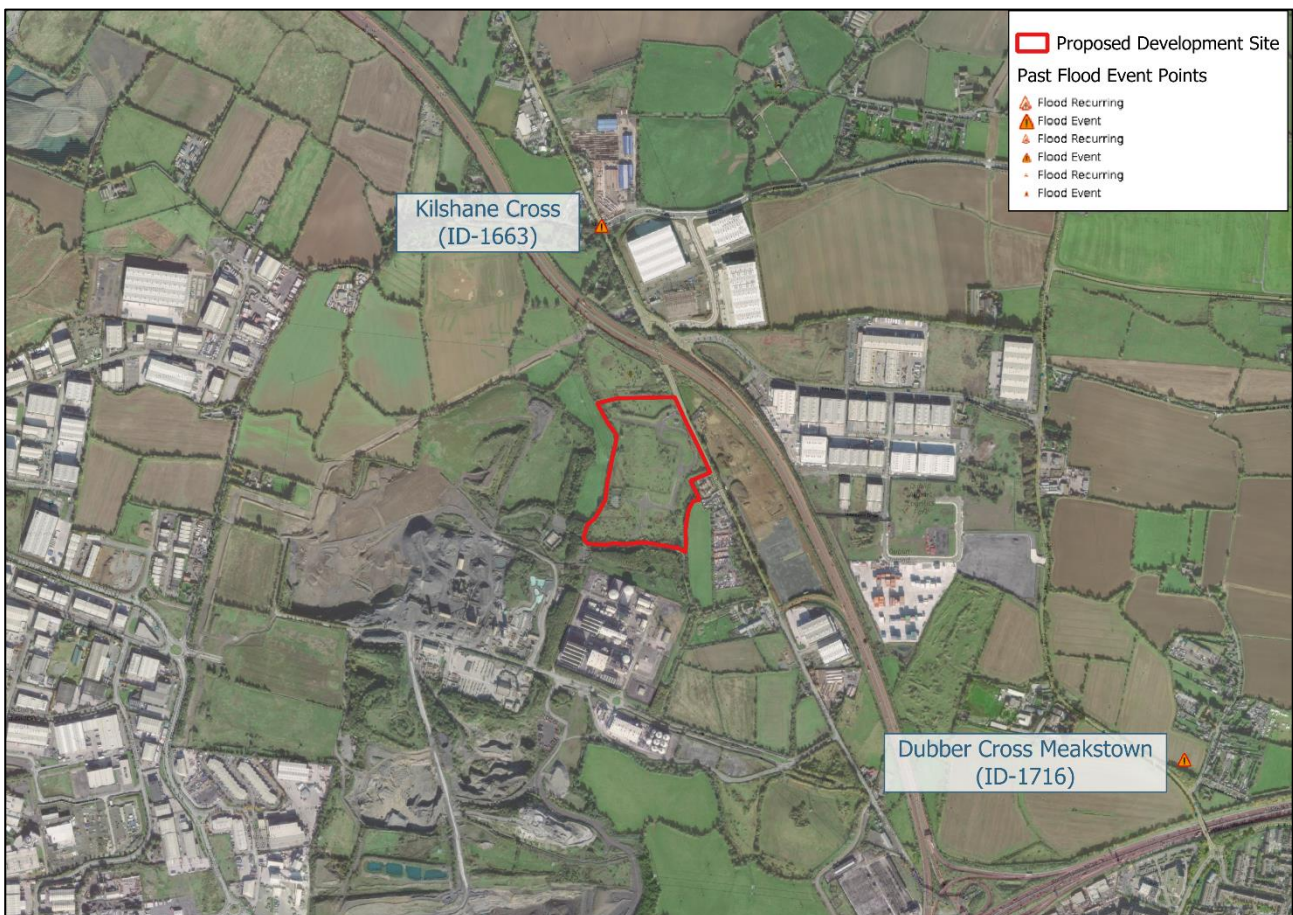

Figure 4-1: Locations of historic flooding ([www.floodinfo.ie](http://www.floodinfo.ie))

### 4.1.2 Anecdotal Evidence

RPS is not aware of any new anecdotal evidence of flooding since the completion of the J.B. Barry & Partners FRA in 2018.

### 4.1.3 GSI Historical Groundwater Flooding

The GSI Groundwater Flooding Data mapping does not show any historical or seasonal groundwater flooding within the vicinity of the proposed development.

## 4.2 Predictive Flood Risk Mapping

### 4.2.1 CFRAM Preliminary Flood Risk Assessment (PFRA) Maps

The Preliminary Flood Risk Assessment (PFRA) is a national screening exercise, based on available and readily derivable information, to identify areas where there may be a significant risk associated with flooding. The PFRA map (extract) is shown in **Figure 4-2** below and in **Appendix C** indicating the flooding extents for the Proposed Development Site.

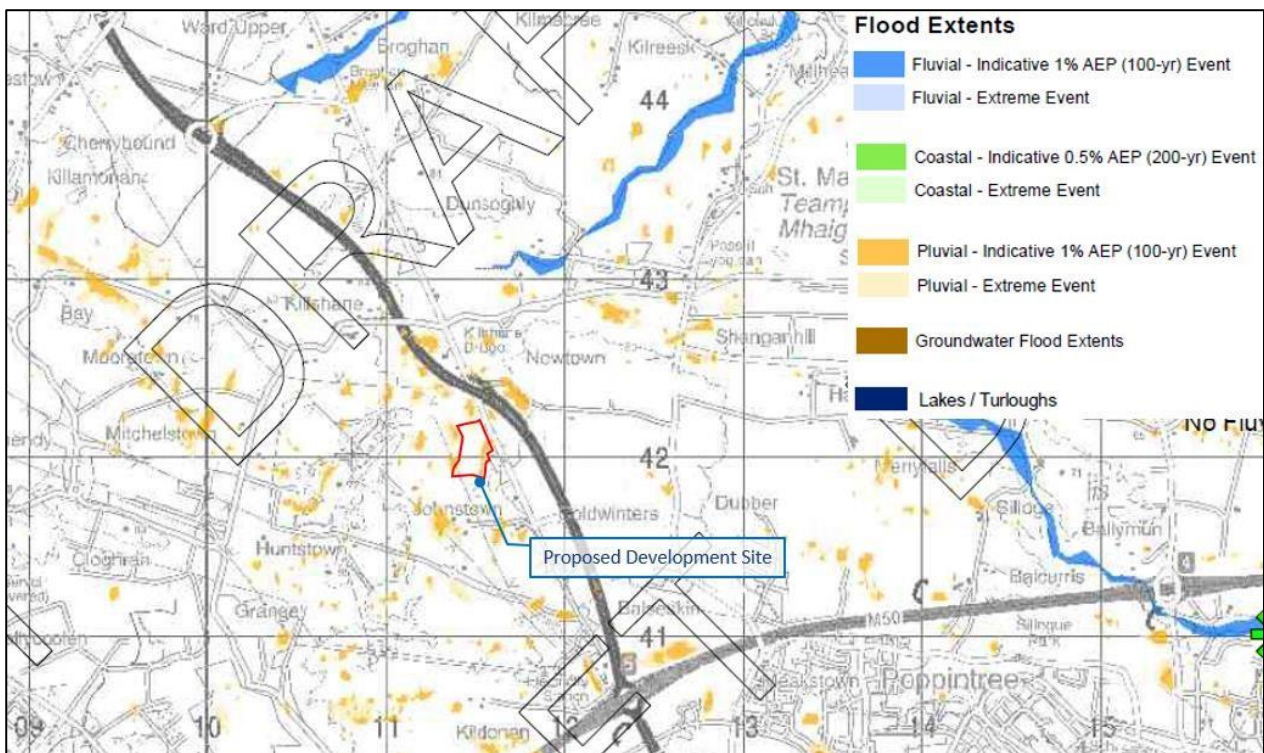

Figure 4-2: Extract of the PFRA map ([www.cfram.ie](http://www.cfram.ie) annotation by J.B. Barry & Partners)

### 4.2.2 Fingal County Strategic Flood Risk Assessment (SFRA) 2023-2029

The Strategic Flood Risk Assessment (SFRA) prepared for the Draft Fingal County Development Plan 2023-2029 provides an assessment of all types of flood risk within the County with the aim to assist Fingal County Council to make informed strategic land-use planning decisions and to formulate flood risk policies.

As part of the SFRA predictive flood maps were prepared in order to identify sources of flooding and produce flood zone maps for across the local authority area and in key development areas. The flood zones are largely derived from the Fingal East Meath Flood Risk Assessment and Management Study (FEMFRAMS) and the Tolka Flooding Study mapping as these are the most comprehensive flood maps produced for Fingal. An extract of the flood map within the vicinity of the proposed development site is shown in **Figure 4-3** below and included in **Appendix D**. This map indicates that the proposed development site lies outside of the 1% and 0.1% AEP fluvial flood extents.

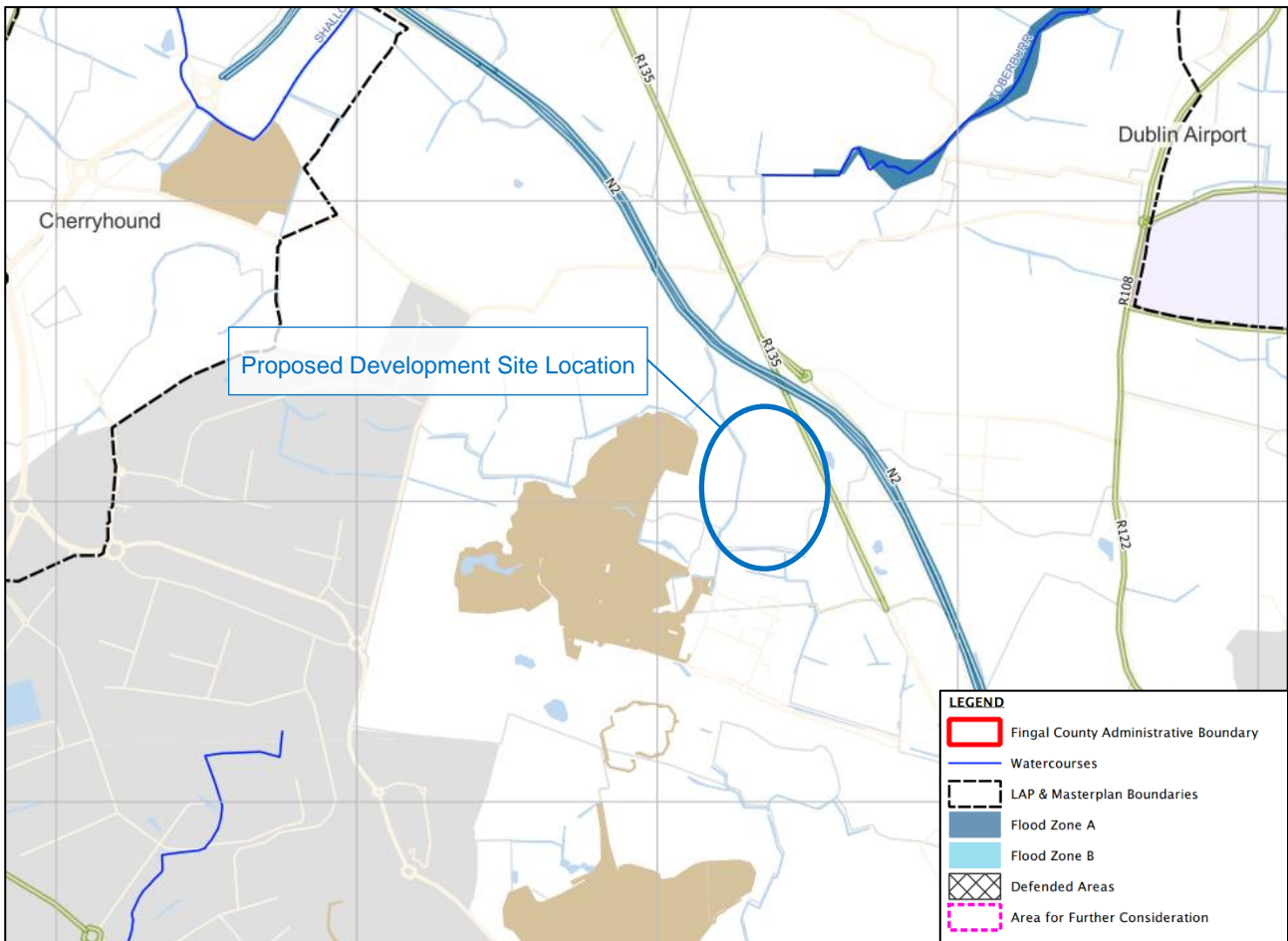

Figure 4-3: Extract from Fingal County SFRA Flood Zone map - Current Scenario

### 4.2.3 Fluvial Flooding

The PFRA flood map (**Appendix C**) indicates that the Proposed Development Site is located outside the extent of the Fluvial - Indicative 1% AEP (100-yr) Event and Fluvial - Extreme Event. It is important to note that the Ballystrahan Stream may not have been modelled as part of the PFRA. Therefore, there is a need to carry out a calculation to determine the height of water in this Stream for the 0.1% AEP to estimate the Flood Zone.

Using Manning’s equation and an estimated flow derived from the catchment area, a water height in the stream was calculated. The tools used include Excel for Manning’s equation (**Figure 4-4**) and HR Wallingford ([www.uksuds.com](http://www.uksuds.com)) for the flow derived from the catchment area (see **Appendix F**). Ground levels are taken from a topographical survey carried out within the Site boundary. The HR Wallingford tool gives flows for the 1 in 1, 30, 100, and 200-year return periods. To reflect a 0.1% AEP, the growth curve was produced for the Site and projected for the 1 in 1000-year return period, giving a growth curve factor of 3.5 which is used in the edited column (see **Appendix F**). The slope (S) used in Manning’s equation is set to 1:1000 based on the proposed surface water drainage layout drawing.

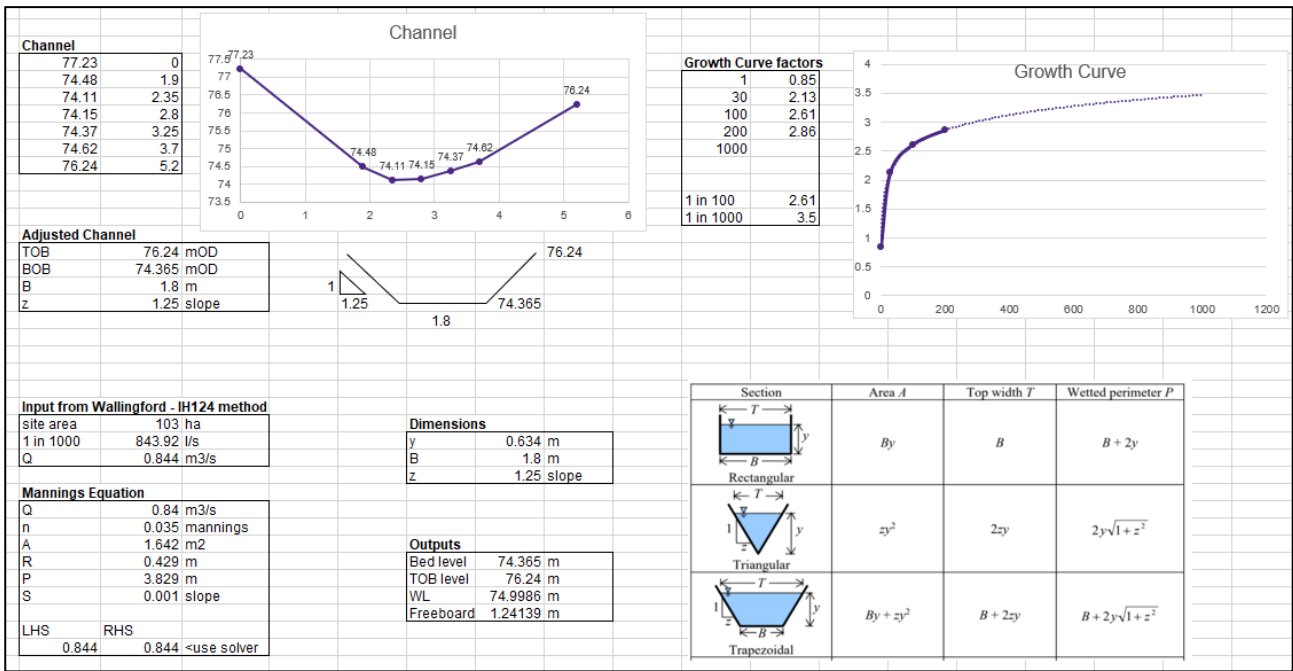

Figure 4-4: Excel Calculations

The height of water within the Stream is estimated at 634mm, giving a freeboard of approximately 1.2m from the top of bank of the examined cross section. There is a low point along the bank line with a difference in height between the top of bank and bottom of bank of 1.37m, giving a freeboard of 736mm using the calculated water height. This indicates the water remains in bank in the 0.1% AEP and the Proposed Development is outside of Flood Zone B.

#### 4.2.4 Pluvial Flooding

The PFRA flood map (**Appendix C**) identifies a risk of pluvial related flooding in the Proposed Development Site. The indicative extents of the pluvial mapping are presented at a regional/national scale and may not be site specific due to the accuracy of this dataset. However, there is no record of pluvial flooding in the OPW Local Area Reports at the Proposed Development Site. There is no historical evidence of the attenuation pond identified within the Proposed Development Site contributing to any flood risk at the site.

#### 4.2.5 Coastal Flooding

The PFRA flood map (**Appendix C**) indicates the Proposed Development Site lies outside the indicative 0.5% AEP (200-yr) Event and the coastal - Extreme Event.

#### 4.2.6 Groundwater Flooding

The PFRA flood map (**Appendix C**) does not show any predictive groundwater flooding in the vicinity of the Proposed Development Site, nor are any springs or wells identified on the Site. Additionally, the GSI Spatial Resources does not show any predictive groundwater flooding extents for the 1% and 0.1% AEP in proximity to the Proposed Development Site.

### 4.3 Stage 1 Conclusion

Upon reviewing the existing information, the proposed development is at low risk of flooding. The proposed development is classed as a “highly vulnerable” development as per the definition in the Fingal SFRA and follows the DOEHLG (2009) Flood Risk Management Planning Guidelines, meaning the nature and scale of the proposed development is appropriate in the context of flood risk without need of the Justification Test (refer to **Appendix A**).

**Table 4-1** presents a summary of the initial flood risk assessment.

**Table 4-1: Summary of Flood Risk Identification**

Sources of Flooding	Comments	Risk
<b>Fluvial</b>	The PFRA flood map indicates that the Proposed Development Site is located outside the extent of the Fluvial - Indicative 1% AEP (100-yr) Event and Fluvial - Extreme Event. It is estimated from calculations that the Site lies in Flood Zone C.	Low
<b>Pluvial</b>	The PFRA flood map identifies a risk of pluvial related flooding in the Proposed Development Site. This may be due to the nature of the data used in the PFRA, but appropriate mitigation measures should be considered.	Low
<b>Coastal</b>	The PFRA flood map indicates the Proposed Development Site lies outside the indicative 0.5% AEP (200-yr) Event and the coastal - Extreme Event.	Low
<b>Groundwater</b>	The PFRA flood map does not show any predictive groundwater flooding in the vicinity of the Proposed Development Site, nor are any springs or wells identified on the Site.	Low

The relevant and available information included within Stage 1 is sufficient to conclude that the site is located within **Flood Zone C** with a low risk of flooding.

However, some potential risk remains in the management of surface water within the site which may lead to potential pluvial flood risk. As such, the FRA was progressed to Stage 2 to assess the proposed surface water management measures from a flood risk perspective.

## 5 INITIAL FLOOD RISK ASSESSMENT – STAGE 2

### 5.1 Mitigation Measures

A pluvial flooding risk has been identified in Stage 1 of this FRA and must be mitigated against accordingly. Therefore, the Proposed Development requires an appropriately designed surface water network utilising SuDS as required by the FCC CDP. This is in accordance with the Greater Dublin Strategic Drainage Study, 2005 which requires all new developments to incorporate SuDS unless it can be demonstrated that such facilities are not feasible. The following mitigation measures are included within the proposed development to appropriately manage the potential of this flood risk.

#### 5.1.1 Proposed Surface Water Infrastructure

The Site has been divided into two catchment areas for surface water management, the ‘northern catchment’ and the ‘southern catchment’ as illustrated in **Figure 5-1**. The surface water run-off from the development (northern catchment) will pass through a treatment train of three SuDS devices. This includes the use of permeable paving, swales, and an attenuation tank as illustrated in **Appendix E**. The southern catchment will continue to follow the existing surface water management regime via the existing network and attenuation pond.

In addition, roof run-off will be conveyed via a series of rainwater down pipes into a rainwater harvesting system. The surface water network has been designed with the aid of Micro Drainage software for no flooding for the 1, 30, and 100 year + 10% critical storm event. Flow control devices at both outfalls will be upgraded to meet discharge rates of 32.6 l/s and 9.88 l/s for the northern and southern catchments respectively. More information on the proposed surface water infrastructure can be found in the Engineering Design Report – RBSF<sup>2</sup> as part of the 2018 planning application.

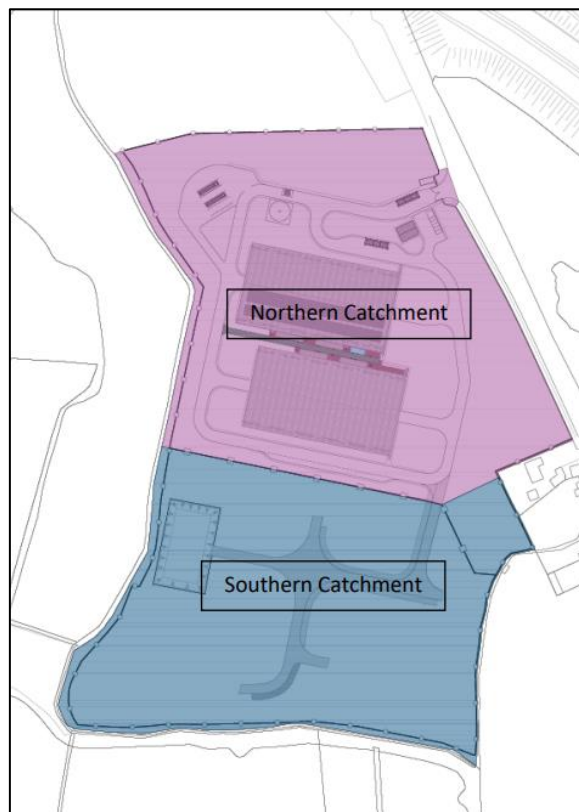

**Figure 5-1: Surface Water Catchments (Engineering Design Report)**

<sup>2</sup> J.B. Barry & Partners et al., 2018. Engineering Design Report – RBSF. [180601\\_RGD Planning App - RBSF Eng Design Report.pdf \(ringsendwwtpupgrade.ie\)](#)



The finished floor levels of the Proposed Development are 77.400mOD. The surrounding hardstanding area of these storage buildings are at 77.250mOD, giving a difference in height of 150mm. In the case of a design exceedance event, the water surcharging from drainage systems will be inclined to flow northwest based on proposed levels, away from the proposed buildings. In addition, the FFL of the proposed buildings, at 77.400mOD, are 2.945m above the invert level of the attenuation tank of 74.455mOD.

### **5.2 Stage 2 Conclusion**

The Proposed Development was identified to have a very low risk of flooding. Pluvial flooding risk that has been identified is deemed appropriate provided the Proposed Development is designed with the proposed mitigation measures incorporated into the design.

## 6 CONCLUSION

Based on the review of existing information referenced throughout this report and the information which has been established as a result of undertaking the flood risk assessment described in this report, the conclusions can be summarised as follows:

- This FRA was carried out in accordance with “The Planning System and Flood Risk Management Guidelines” (DOEHLG, 2009) and with guidance from the SFRA completed as part of the Fingal CDP 2023-2029.
- The proposed development consists of the construction 2 no. warehouses for the storage of biosolids and ancillary works at Newton, Dublin 11.
- The Huntstown Stream, a tributary to the River Ward, flows near the north western boundary of the site. The Ballystrahan Stream, a tributary to the Huntstown Stream, contributes minor flows along the southern and western boundaries of the Proposed Development Site.
- The proposed development is classified as “highly vulnerable” and is located within Flood zone C, therefore a Justification Test is not required. The proposed development is at low risk of flooding.
- There are no records of historical flooding within and in the immediate vicinity of the proposed development.
- The PFRA map identified a risk of flooding to the existing site due to pluvial flooding. To mitigate this risk, appropriate SuDS measures are proposed to ensure all surface water is managed sufficiently and sustainably discharged to the drainage network.

## Appendix A The Planning System and Flood Risk Management

In September 2008 “The Planning System and Flood Risk Management Guidelines” (the guidelines) were published by the Department of the Environment, Heritage and Local Government in Draft format. In November 2009 the adopted version of the document was published.

The guidelines give guidance on flood risk and development. The guidelines recommend a precautionary approach when considering flood risk management in the planning system.

Foremost, flood risk is a combination of the likelihood/probability of flooding and the potential consequences arising.

### Flood Risk = Likelihood of Flooding x Consequences of Flooding

The assessment of flood risk requires the understanding of where the water comes from (i.e. the source), how and where it flows (i.e. the pathways) and the people and assets affected by it (i.e. the receptors). This is highlighted in the Figure below which is extracted from the guidelines.

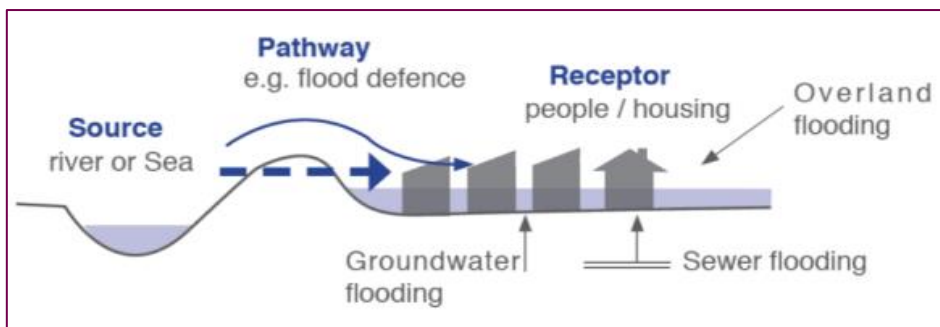

Sources, Pathways and Receptors of Flooding (Extract from PSFRM)

The core principle of the guidelines is to adopt a risk based sequential approach to managing flood risk and to avoid development in areas that are at risk (refer to Figure below). The sequential approach is based on the identification of flood zones for river and coastal flooding.

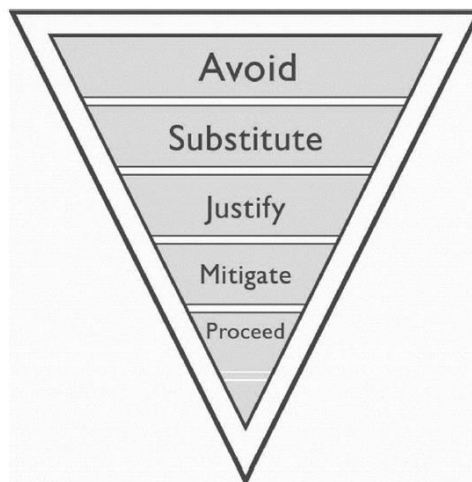

Sequential approach principles in flood risk management

The guidelines include definitions of Flood Zones A, B and C as noted below. It should be noted that these do not take into account the presence of flood defences, as risks remain of overtopping and breach of the defences.

**Zone A** (high probability of flooding) is for lands where the probability of flooding is greatest (greater than 1% or the 1 in 100 for river flooding and 0.5% or 1 in 200 for coastal flooding).

**Zone B** (moderate probability of flooding) refers to lands where the probability of flooding is moderate (between 0.1% or 1 in 1,000 and 1% or 1 in 100 for river flooding and between 0.1% or 1 in 1,000 and 0.5% or 1 in 200 for coastal flooding).

**Zone C** (low probability of flooding) refers to lands where the probability of flooding is low (less than 0.1% or 1 in 1,000 for both river and coastal flooding).

Once a flood zone has been identified, the guidelines set out the different types of development appropriate to each zone. Exceptions to the restriction of development due to potential flood risks are provided for through the use of the **Justification Test**, where the planning need and the sustainable management of flood risk to an acceptable level must be demonstrated as shown in Table below. This recognises that there will be a need for future development in existing towns and urban centres that lie within flood risk zones, and that the avoidance of all future development in these areas would be unsustainable.

**Matrix of Development Vulnerability vs Flood Zone (Extract from PSFRM)**

	Flood Zone A	Flood Zone B	Flood Zone C
Highly vulnerable development (including essential infrastructure)	Justification Test	Justification Test	Appropriate
Less vulnerable development	Justification Test	Appropriate	Appropriate
Water-compatible development	Appropriate	Appropriate	Appropriate

A three-staged approach to undertaking an FRA is recommended:

**Flood Risk Identification (Stage 1)** - Identification of any issues relating to the site that will require further investigation through a Flood Risk Assessment.

**Initial Flood Risk Assessment (Stage 2)** - Involves establishment of the sources of flooding, the extent of the flood risk, potential impacts of the development and possible mitigation measures.

**Detailed Flood Risk Assessment (Stage 3)** - Assess flood risk issues in sufficient detail to provide quantitative appraisal of potential flood risk of the development, impacts of the flooding elsewhere and the effectiveness of any proposed mitigation measures.

## Potential Sources of Flooding

When carrying out a flood risk assessment one should consider all the potential flood risks and sources of flood water at the site. Generally, the relevant flood sources are:

### Fluvial Flooding

Fluvial flooding refers to flooding from rivers and streams. Fluvial flooding is the result of a river/stream exceeding its channel capacity and excess water spilling out onto the adjacent floodplain. The process of flooding on watercourses depends on a number of characteristics associated within the catchment including geographical location, and variation in rainfall, steepness of the channel and surrounding floodplain and infiltration rate of runoff associated with urban and rural catchments.

### Coastal Flooding

Coastal flooding results from sea levels which are higher than normal and result in sea water overflowing onto the land. Coastal flooding is influenced by the following three factors which often work in combination: tides, storm surges, and wave action.

### **Pluvial Flooding**

Pluvial flooding relates to flooding as a direct result of extreme rainfall. Pluvial flooding can occur during a rainfall event of extreme intensity. If the rate at which water falls on the ground is faster than the rate at which the water can make its way to the drainage network, then flooding will occur. This type of flood is also referred to as 'ponding' and typically occurs during summer months.

### **Groundwater Flooding**

Groundwater flooding can occur during lengthy periods of heavy rainfall, typically during later winter/early spring when the groundwater table is already high. If the groundwater level rises above surface level, it can pond at local points and cause periods of flooding.

## Appendix B OPW Summary Local Area Reports



Report Produced: 19/7/2023 12:26

This Past Flood Event Summary Report summarises all past flood events within 2.5 kilometres of the map centre.

This report has been downloaded from [www.floodinfo.ie](http://www.floodinfo.ie) (the "Website"). The users should take account of the restrictions and limitations relating to the content and use of the Website that are explained in the Terms and Conditions. It is a condition of use of the Website that you agree to be bound by the disclaimer and other terms and conditions set out on the Website and to the privacy policy on the Website.

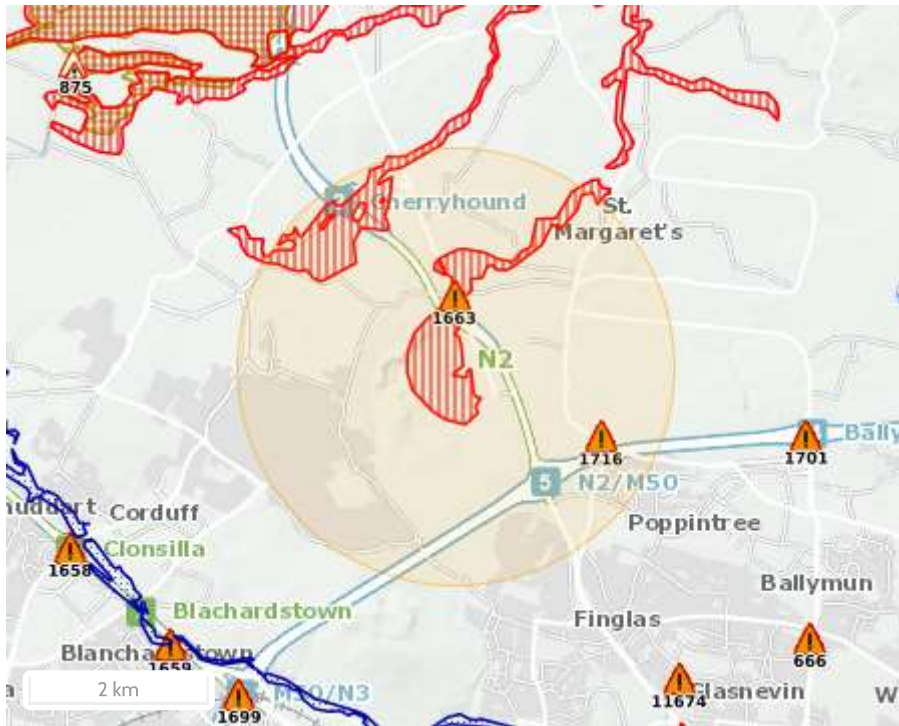

## Map Legend

- Single Flood Event
- Recurring Flood Event
- Past Flood Event Extents
- Drainage Districts Benefited Lands\*
- Land Commission Benefited Lands\*
- Arterial Drainage Schemes Benefited Lands\*

\* Important: These maps do not indicate flood hazard or flood extent. Their purpose and scope is explained on [Floodinfo.ie](http://Floodinfo.ie)

## 2 Results

Name (Flood_ID)	Start Date	Event Location
1.  Kilshane Cross Nov 2002 (ID-1663) Additional Information: <a href="#">Reports (2)</a> , <a href="#">Press Archive (0)</a>	13/11/2002	Exact Point
2.  Dubber Cross Meakstown Swords Area Nov 2002 (ID-1716) Additional Information: <a href="#">Reports (1)</a> , <a href="#">Press Archive (0)</a>	14/11/2002	Exact Point

## MEETING OF COUNTY COUNCIL 9/12/2002

### Item No. 22

#### Report on Flooding in Fingal Area

#### In 2000 and 2002

A report was presented to the Council meeting on 29<sup>th</sup> January 2001 on flooding which occurred in the Fingal area over the period 5<sup>th</sup> - 7<sup>th</sup> November 2000 and 7 - 8<sup>th</sup> November 2002. The report identified 12 key areas for attention and the up to date position is set out hereunder:-

1. N1 at Blakes Cross and Turvey Avenue - both flooded
2. N2 at Coolquay/Ward Road - road and property flooding
3. Balbriggan/Boranstown - property flooding.  
  
Note: remedial work has been carried out at all three locations and flooding did not re-occur over the period 13<sup>th</sup> - 15<sup>th</sup> November 2002.
4. Newcourt, Swords - property flooded. Work on the new treatment works in Swords has now solved this issue and no flooding occurred over the period 13<sup>th</sup> - 15<sup>th</sup> November 2002.
5. Bremore Court - property flooded. A contract to construct new surface water culvert under the N1 is to commence in early 2003. Some flooding occurred at this location over the period 13<sup>th</sup> - 15<sup>th</sup> November 2002 but it is not considered as extensive as that which occurred in 2000.
6. R132 - Cloghran, Old Airport Road. This road flooded at 2 locations within 300 metres of the M50 in 2000. At the first location close to the M50 the section of culvert underneath the Old Airport Road was fully cleared out by Fingal County Council after events in 2000 however it is considered that additional work is necessary on sections of this culvert downstream of the location on land in private ownership.

The other section of road 300m approximately to the North of the M50 contains 300mm diameter culvert which requires regular maintenance. Replacement of this culvert at the larger size is severely hampered by the extent of services for other utilities already present in the road. Both locations referred to flooded over the period 13<sup>th</sup> - 15<sup>th</sup> November 2002.



7. Portersgate, Clonsilla - (property) houses and gardens. The problem at this location is being considered as part of the Greater Dublin Strategic Drainage Study being undertaken at present. The results of this study are expected in May 2003. Fingal County Council in consultation with the Consultant on this study are proposing a series of interim measures to alleviate the situation. These measures are expected to be installed early in 2003 and address the issue of the possible effects of surcharging in the foul sewerage system in the area on low lying properties in the Portersgate area.  
  
No properties were flooded 13<sup>th</sup> - 15<sup>th</sup> November 2002 as a result of the prompt action of Drainage Maintenance, Fingal County Council.  
  
The estate has been threatened with flooding on a previous occasion since the events in 2000.
8. Pinebrook/Hartstown - flooding (property) houses and gardens.  
  
Flooding occurred again at this location in 2000 and again in the period 13<sup>th</sup> - 15<sup>th</sup> November 2002. Action has been taken to clean the culvert since and a detailed assessment of the capacity of the culvert is underway at present.
9. R109 - Lucan (Strawberry Beds) - road and houses flooded. This problem relates to the Liffey. The Greater Drainage Strategic Study is considering issues in relation to the Liffey at present and the Consultants will be asked to address specifically the problems of flooding which are occurring in this location with a view to identifying interim measures which can be undertaken to alleviate the issue. The road was flooded at this location over the period 13<sup>th</sup> - 15<sup>th</sup> November 2002.
10. N3 - Near Blanchardstown Town Centre - road flooding. Flooding related directly to the level of flows in the Tolka. Consultants on the Greater Dublin Drainage Study have been asked to consider this issue specifically with a view to recommending interim measures that may be provided pending completion of their report in May 2003. Road flooded again at this location over the period 13<sup>th</sup> - 15<sup>th</sup> November 2002.
11. R128 - Lusk/Rush - road flooding. A full cleaning of the downstream channel was undertaken in early 2000 in addition to full cleaning of the road culverts at the location. The road was subject to severe flooding at this location over the period 13<sup>th</sup> - 15<sup>th</sup> November 2002 and was impassable to cars. A nearby location at Whitestown was also flooded but remained passable to vehicular traffic. Fingal County Council as an urgent interim measure are arranging for the replacement of the existing culverts at the Spout Road location with a larger capacity culvert. This work is expected to commence in early January 2003 and more careful consideration will be given to the possibility of phasing the levels of the road to help avoid extreme ponding at that location.

12. Rush/Loughshinny - road flooded. The problem here relates to the capacity of the existing culvert under the road where flooding has taken place. It is exacerbated by the presence of a foul sewer on the down stream outlet of the culvert which further constricts flows. Measures to relocate the foul sewer and improve the road crossing at that location are identified as an objective in the Area Action Plan for Rush which is presently before the members for consideration.

#### Areas flooded in November 2002 (not previously flooded)

A total rainfall of 86.8mm fell in the 3 day period 13<sup>th</sup> - 15<sup>th</sup> November 2002. An interim report on these events has been presented to the members of each Area Committee and a report is attached - Appendix A.

The principal areas affected severely which had not been flooded in 2002 were:

Littlepace, Castaheany	-	Houses flooded
Castlecurragh	-	Houses flooded

The Consultants on the Greater Dublin Drainage Study, MC O'Sullivan Consulting Engineers have been requested to examine these locations specifically to identify interim measures that may be possible to alleviate the risk of future flooding.

Severe flooding also occurred on this occasion on

- (i) M50 at the N3 Interchange
- (ii) M50 at Ballymun Exit

Remedial measures to road drainage have been undertaken at these locations.

- (iii) N2 at Kilshane Cross

Preliminary investigations indicate that flooding on the N2 arose from surface water run off from adjacent grasslands.

Landowners are required to undertake necessary steps to prevent run off onto roads. In this instance the matter is being taken up with the landowners concerned.

- (iv) N1 at Roundabout at Fingallions

Flooding occurred due to the high water level in the Ward River. A temporary contraflow emergency measure operated successfully and ensured that the N1 remained open to traffic.

- (v) Swords/Ashbourne Road

Flooding occurred at Rathbeale Cross and Rowlestown. A new culvert is being installed at present at Rathbeale Cross and drainage alleviation works are underway at Rowlestown.

(vi) Santry Close

Flooding occurred on the Old Airport Road at this location arising from high water levels in the Santry River. Interim alleviation measures are being undertaken by the developer at Santry Demesne to prevent a recurrence.

Other locations where flooding occurred are listed in Appendix B.

## MINUTES OF MEETING

Reference: P4D403A – F140 – 014- 004 Page 1 of 2

Project No.: P4D403A

Project Title: OPW Flood Hazard Mapping – Phase 1

Purpose of Meeting: Data Collection No. 4 – Fingal County Council

Participating: Roads Engineering Staff – West (3 No) Roads Fingal CC  
Search Manager ESBI

Venue: Fingal Road Depot, Coolmine

Date of Meeting: 18/04/05

Copies to: File

Compiled by: Search Manager

Status: Approved

Approved for ESBI: Search Manager

Approved for Fingal County Council: Local Project Co-ordinator

Date: December 2005



Copies of the following documents were received.

- F. Meeting of County Council 9/12/2002, Item No. 22. Report on Flooding in Fingal Area in 2000 and 2002. (4 pages)
- G. Flooding Reports 26<sup>th</sup> to 28<sup>th</sup> October 2004. (1 page)
  - Printed A4 colour pictures (7 No.) showing flooding on Blanchardstown Bypass/Navan Road (N3) in November 2002

The Area Engineer's district of responsibility is approximately that area west of the N2. Those locations, identified previously by Fingal Drainage Section as prone to flooding, were reviewed and a number of additional locations highlighted.

- 41. Navan Road – Tolka River upstream of Mulhuddart (Flood ID No 1655)  
Tolka River overflows its banks regularly just upstream of confluence with Pinkeen River. A protective berm was built around factory buildings in 2004.
- 42. Navan Road – adj. Tolka Valley Park (Flood ID No 1658)  
A protective berm, between Tolka River and Navan Road, was constructed in 2004. Severe flooding of road along Blanchardstown Bypass at this location in November 2002 (not 2000) due to high river levels and surface water drainage backup. Road impassable and cars submerged (see photos) under Snugborough Road flyover. A protective berm, between Tolka River and Navan Road, was constructed in 2004. (See document F)
- 43. Herbert Road, Blanchardstown (Flood ID No 1659)  
Gardens of houses along this cul-de-sac were flooded. Also sub floor of 1 house. Protective berm constructed in 2004.
- 44. Pinebrook, Hartstown. (Flood ID No 1660)  
Surface water ditches in Hartstown surcharged in 2000 turning park into a lake and flooding houses in Pinebrook. Subsequent remedial works (including piping drains) have been carried out. (See document F)
- 45. Lower Lucan Road/Strawberry Beds
  - a. near Tinkers Hill. Road level low and impacted when Liffey in flood. (Flood ID No 1661)
  - b. between Sommerton Road & Luttrellstown GC. Road level impacted when Liffey in flood. Usually passable. Impassable in 2004 due to surface water from Porterstown/Luttrellstown Golf Club unable to exit due to blockage of drainage pipe by local landowner. (Flood ID No 1694, 2190)(See document F.)
- 46. Kilshane Cross on N2  
Flooded in November 2002. Drainage works (2005) being carried out as part of road development. (See document F) (Flood ID No 1663)

# Appendix C PRFA Map

© Government of Ireland  
Osi permit number EN-002-1011

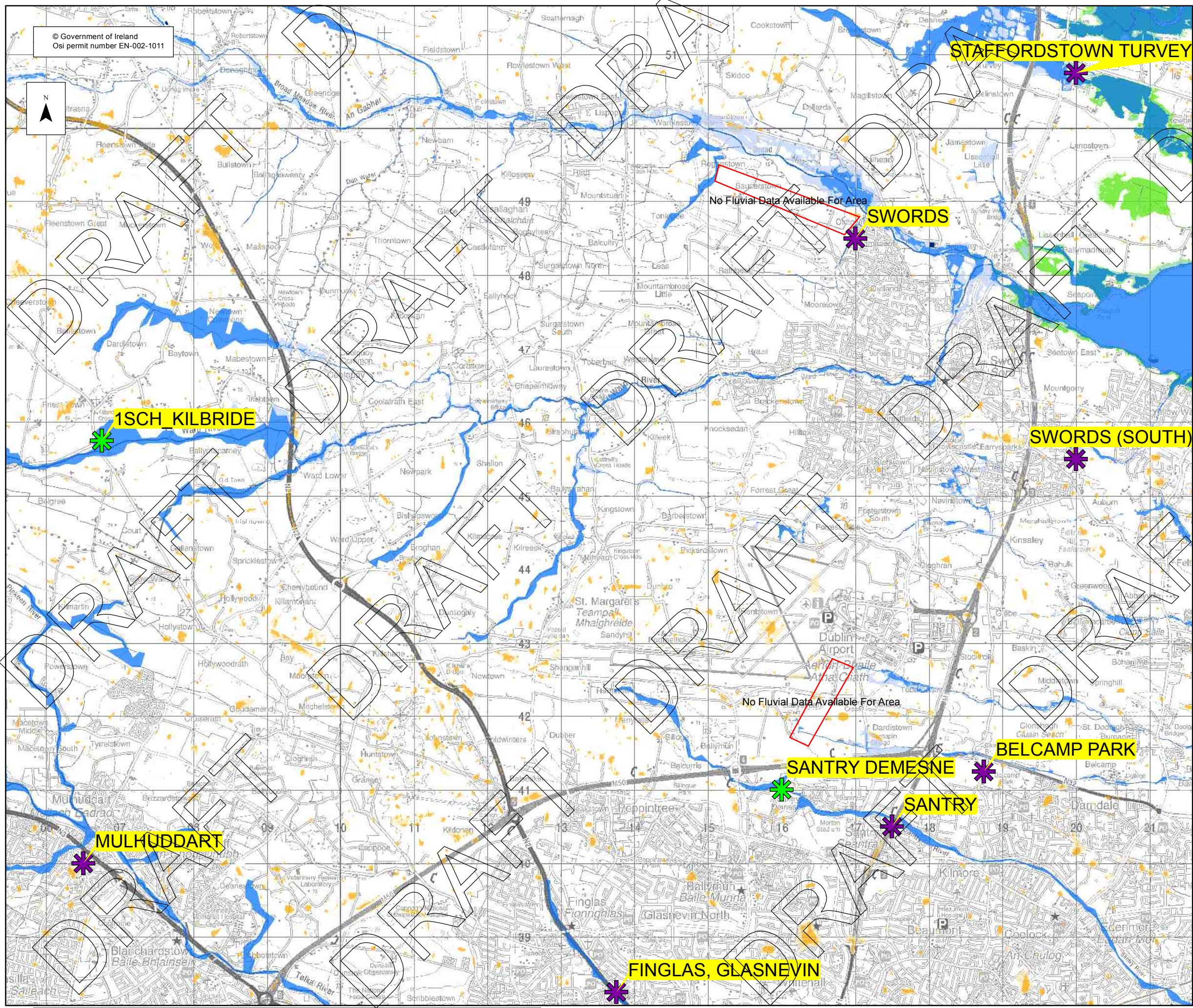

**Location Plan :**

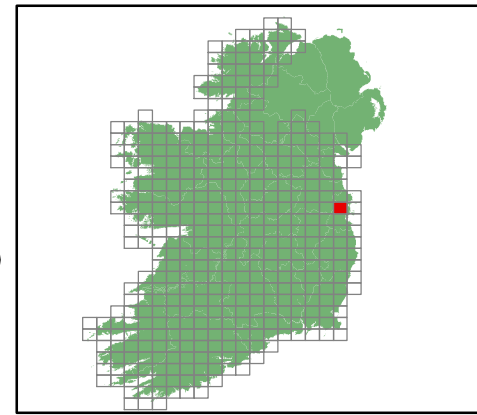

**Legend:**

- Flood Extents**
- Fluvial - Indicative 1% AEP (100-yr) Event
  - Fluvial - Extreme Event
  - Coastal - Indicative 0.5% AEP (200-yr) Event
  - Coastal - Extreme Event
  - Pluvial - Indicative 1% AEP (100-yr) Event
  - Pluvial - Extreme Event
  - Groundwater Flood Extents
  - Lakes / Turloughs
- PFRA Outcomes**
- ✱ Probable Area for Further Assesment
  - ✱ Possible Area for Further Assesment

**Important User Note:**  
The flood extents shown on these maps are based on broad-scale simple analysis and may not be accurate for a specific location. Information on the purpose, development and limitations of these maps is available in the relevant reports (see www.cfram.ie). Users should seek professional advice if they intend to rely on the maps in any way.

If you believe that the maps are inaccurate in some way please forward full details by contacting the OPW (refer to PFRA Information leaflets or 'Have Your Say' on www.cfram.ie).

Office of Public Works  
Jonathon Swift Street  
Trim  
Co Meath  
Ireland

Project :  
**PRELIMINARY FLOOD RISK ASSESMENT (PFRA)**

Map :  
PFRA Indicative extents and outcomes  
- Draft for Consultation

Figure By : PJW                      Date : July 2011  
Checked By : MA                      Date : July 2011

Figure No. :  
2019 / MAP / 256 / A                      Revision  
0

Drawing Scale : 1:50,000                      Plot Scale : 1:1 @ A3

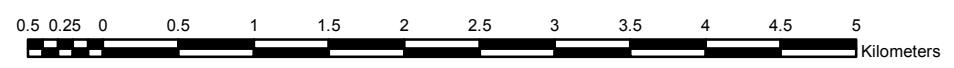

## Appendix D Fingal CC SFRA Flood Zone Map



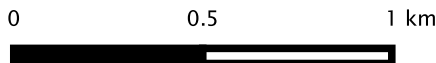
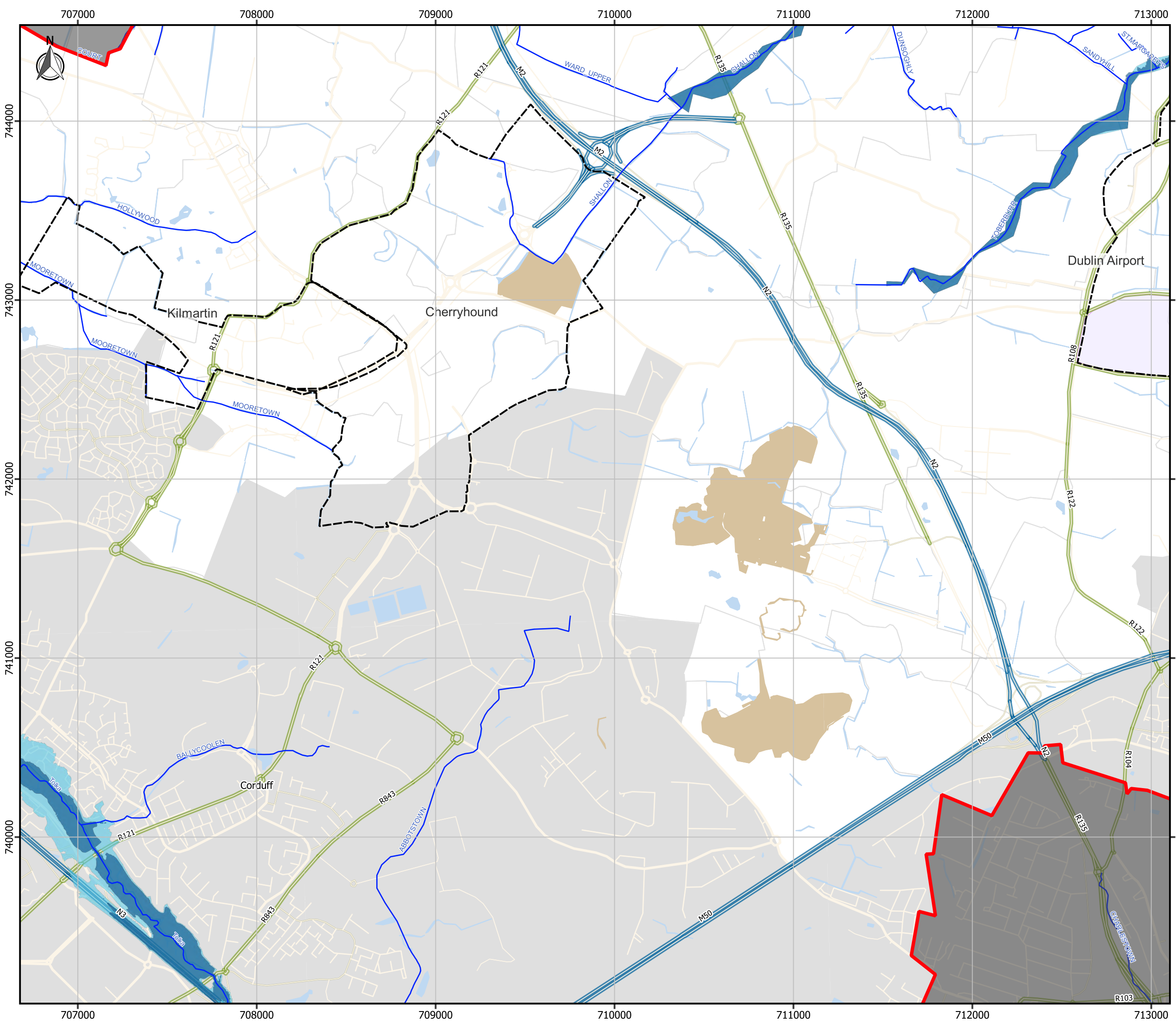

© ORDNANCE SURVEY IRELAND. ALL RIGHTS RESERVED. USAGE PROVIDED BY FINGAL COUNTY COUNCIL LICENCE NO. 021/OSI\_NMA\_057

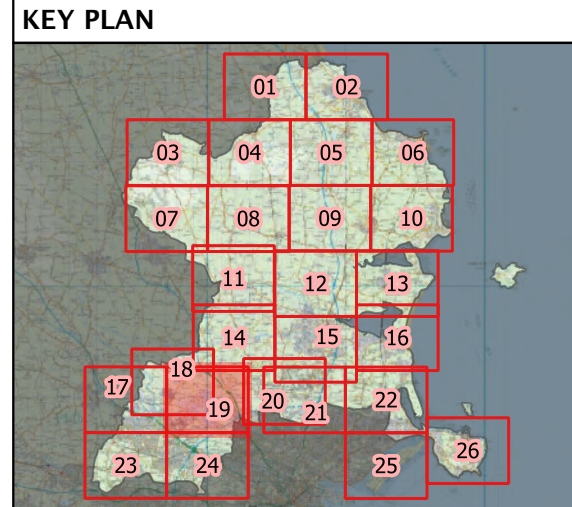

**LEGEND**

- Fingal County Administrative Boundary
- Watercourses
- LAP & Masterplan Boundaries
- Flood Zone A
- Flood Zone B
- Defended Areas
- Area for Further Consideration

<b>REV:</b> 03	<b>NOTE:</b> DRAFT ISSUE	<b>DATE:</b> 22/02/2022
-------------------	-----------------------------	----------------------------

**Comhairle Contae  
Fine Gall  
Fingal County  
Council**

**M'Cloy Consulting**

Unit 12, The Beat Centre,  
Stephenstown Industrial  
Estate,  
Balbriggan, Co. Dublin

T: +353 (0)1 5138963  
E: info@mcclloyconsulting.ie  
W: www.mcclloyconsulting.ie

**MAP:** FLOOD ZONE MAP

**FLOOD PROBABILITY:**

FLUVIAL: 1% / 0.1%	COASTAL: 0.5% / 0.1%
--------------------	----------------------

<b>SOURCE CRS:</b>	ITM EPSG:2157
--------------------	---------------

<b>DRAWN BY:</b>	DL	<b>DATE:</b> 22/02/2022
------------------	----	-------------------------

<b>CHECKED BY:</b>	PS	<b>DATE:</b> 22/02/2022
--------------------	----	-------------------------

<b>APPROVED BY:</b>	DKS	<b>DATE:</b> 22/02/2022
---------------------	-----	-------------------------

**DRAWING NUMBER:**  
M02127-06\_FIG\_FL119

<b>MAP SERIES:</b>	PAGE 19 OF 26
--------------------	---------------

<b>DRAWING SCALE:</b>	1:20000 @ A3
-----------------------	--------------

## Appendix E Surface Water Drainage Layout

NOTE: CONFIDENTIAL NO THIRD PARTY DISCLOSURE ALLOWED  
 All rights reserved.  
 © J.B. Barry and Partners  
 T.J. O'Connor and Associates  
 Royal Haskoning DHV 2014

1. All levels are in metres and relate to D.S. Datum MALIN.  
 2. This drawing is reproduced from digital maps:  
 O.S. MAPS - Scale 1:2500  
 O.S. MAPS - Scale 1:1250  
 Discovery Series - Scale 1:50,000  
 3. All Maps are referenced to IRISH NATIONAL GRID (I.T.M.)  
 4. Reproduced from the Ordnance Survey of Ireland by Permission of the Government. License No. 3/3/04.

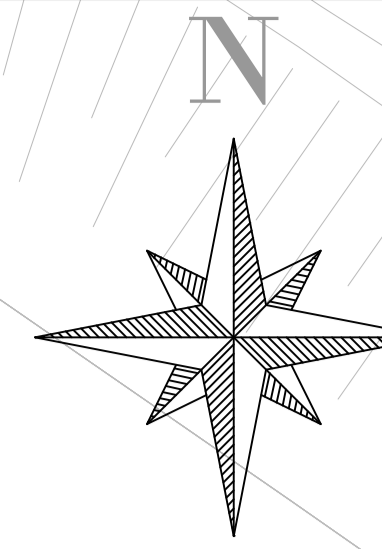

TOWNLAND OF NEWTOWN

LEGEND:

- SITE DEVELOPMENT BOUNDARY
- PROPOSED SURFACE WATER DRAINAGE
- PROPOSED RAINWATER HARVESTING (RW)
- DIVERTED SURFACE WATER DRAINAGE
- EXISTING SURFACE WATER DRAINAGE
- PUMPED FEED PIPE
- SECTION OF EXISTING SURFACE WATER DRAINAGE TO BE DIVERTED
- G GULLY
- S SWALES
- E EXISTING ROADS & FOOTPATH
- R REINFORCED GRASS
- P PERMEABLE PAVING
- W PROPOSED PLANTING
- B BOUNDARY WALL (TYPE 1)
- C CHAINLINK FENCING (TYPE 2)
- F PALISADE FENCING (TYPE 3)
- E EXISTING MAN-HOLE REFERENCE COVER LEVEL
- I INVERT LEVEL

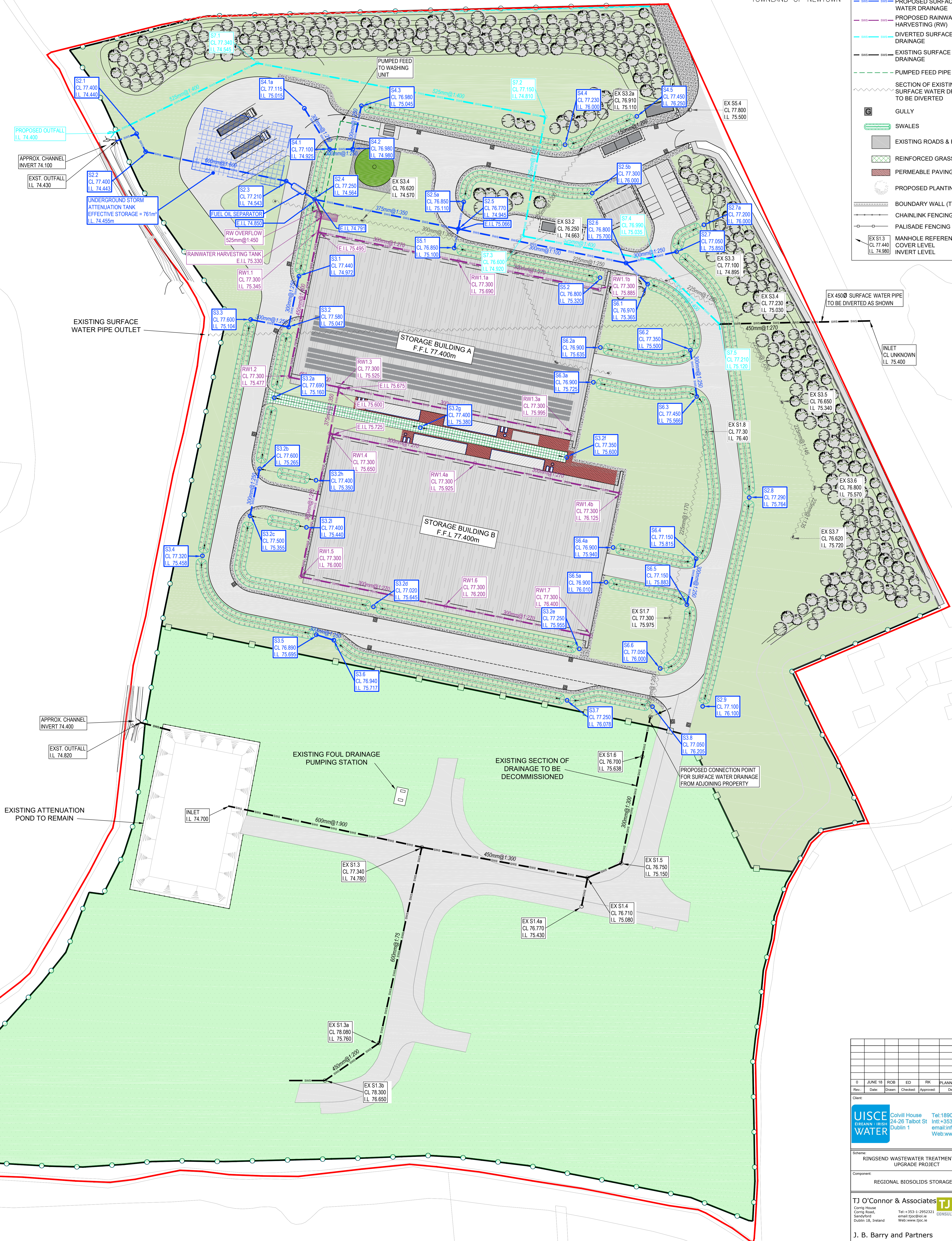

APPROX. CHANNEL  
INVERT 74.400  
EXST. OUTFALL  
I.L. 74.430

EXISTING ATTENUATION  
POND TO REMAIN

APPROX. CHANNEL  
INVERT 74.100  
EXST. OUTFALL  
I.L. 74.430

EXISTING SURFACE  
WATER PIPE OUTLET

EXISTING FOUL DRAINAGE  
PUMPING STATION

EXISTING SECTION OF  
DRAINAGE TO BE  
DECOMMISSIONED

PROPOSED CONNECTION POINT  
FOR SURFACE WATER DRAINAGE  
FROM ADJOINING PROPERTY

EX 4500 SURFACE WATER PIPE  
TO BE DIVERTED AS SHOWN

INLET  
CL UNKNOWN  
I.L. 74.400

EX S3.6  
CL 76.800  
I.L. 75.570

EX S3.7  
CL 76.620  
I.L. 75.720

EX S1.8  
CL 77.300  
I.L. 76.400

EX S3.5  
CL 76.650  
I.L. 75.340

EX S3.4  
CL 77.230  
I.L. 75.030

EX S3.3  
CL 77.100  
I.L. 74.895

EX S2.8  
CL 77.200  
I.L. 76.000

EX S2.7  
CL 77.050  
I.L. 76.600

EX S2.6  
CL 76.800  
I.L. 75.700

EX S3.2  
CL 76.250  
I.L. 74.663

EX S3.4  
CL 76.620  
I.L. 74.570

EX S4.5  
CL 77.450  
I.L. 76.250

EX S3.2a  
CL 76.910  
I.L. 75.110

EX S4.4  
CL 77.230  
I.L. 76.000

EX S4.3  
CL 76.980  
I.L. 75.045

EX S4.2  
CL 76.980  
I.L. 74.980

EX S4.1a  
CL 77.115  
I.L. 75.815

EX S4.1  
CL 77.100  
I.L. 74.925

EX S2.4  
CL 77.250  
I.L. 74.564

EX S2.5  
CL 76.770  
I.L. 74.943

EX S2.5a  
CL 76.850  
I.L. 75.110

EX S2.5b  
CL 76.770  
I.L. 76.000

EX S2.7a  
CL 77.200  
I.L. 76.000

EX S2.7b  
CL 77.050  
I.L. 75.030

EX S2.7c  
CL 77.050  
I.L. 75.030

EX S2.7d  
CL 77.050  
I.L. 75.030

EX S2.7e  
CL 77.050  
I.L. 75.030

EX S2.7f  
CL 77.050  
I.L. 75.030

EX S2.7g  
CL 77.050  
I.L. 75.030

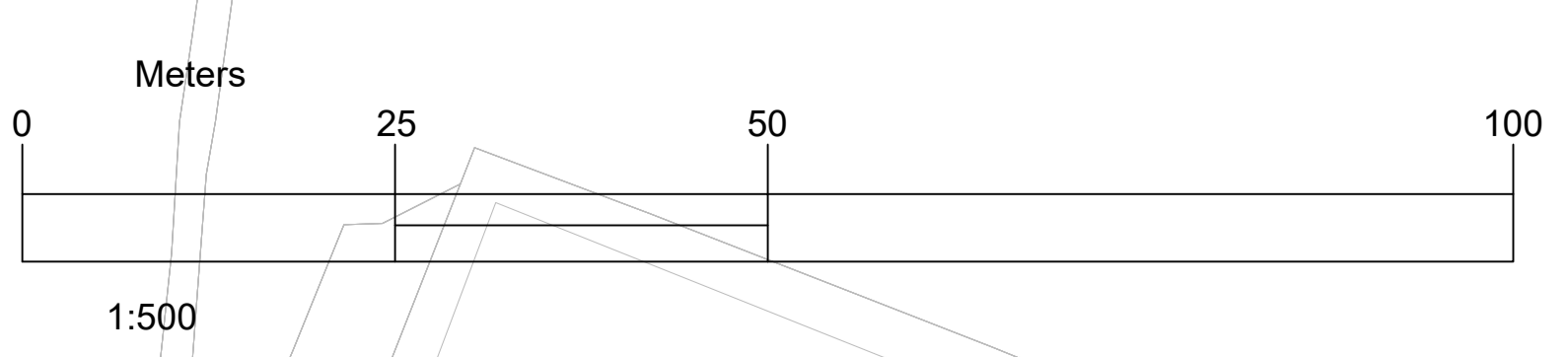

Rev.	Date	Drawn	Checked	Approved	Description
0	JUNE 18	ROB	ED	RK	PLANNING APPLICATION

Client:			
Company:	Colville House	Tel: 1890 278 278	
	24-26 Talbot St	Int: +353-1-707 2628	
	Dublin 1	email: info@uisce.ie	
		Web: www.uisce.ie	

Scheme:	RINGSSEND WASTEWATER TREATMENT PLANT UPGRADE PROJECT		
Component:	REGIONAL BIOSOLIDS STORAGE FACILITY		

Company:			
Company:	Colville House	Tel: +353-1-2952321	
	24-26 Talbot St	email: info@tjoc.ie	
	Dublin 1	Web: www.tjoc.ie	

Company:			
Company:	Classon House	Tel: +353-1-485 1400	
	Dundrum Business Park	email: info@jbarry.ie	
	Dundrum Road	Web: www.jbarry.ie	
	Dublin 14		

Company:			
Company:	PO Box 1133	Tel: +31-88-1482000	
	3800 EC Amersfoort	email: info@rhdhv.com	
	The Netherlands	Web: www.royalhaskoningdhv.com	

Drawn By:	ROB	Checked By:	ED	Approved By:	RK	Date:	JUN 2018
Client Project Ref:	RW-RGD/10000308	Project Stage:	PLANNING				
Internal Project Ref:	Ring11/BB-177021/JOC-14040/RH/DHV-BB4342						
Drawing Title:	SURFACE WATER DRAINAGE LAYOUT						
Scale:	1:500(A0) NTS(A3)						
Drawing Register No:	015	Drawing No.:	Y17702-PL-015	Rev:	0		

## Appendix F Catchment Area and Flow Calculations

Calculated by: JP .

Site name: RBSF

Site location: Newtown

## Site Details

Latitude: 53.41687° N

Longitude: 6.32457° W

Reference: 4225121423

Date: Jul 21 2023 09:46

This is an estimation of the greenfield runoff rates that are used to meet normal best practice criteria in line with Environment Agency guidance "Rainfall runoff management for developments", SC030219 (2013) , the SuDS Manual C753 (Ciria, 2015) and the non-statutory standards for SuDS (Defra, 2015). This information on greenfield runoff rates may be the basis for setting consents for the drainage of surface water runoff from sites.

Runoff estimation approach

## Site characteristics

Total site area (ha):

## Methodology

$Q_{BAR}$  estimation method: Calculate from SPR and SAAR

SPR estimation method: Calculate from SOIL type

## Notes

(1) Is  $Q_{BAR} < 2.0$  l/s/ha?

When  $Q_{BAR}$  is  $< 2.0$  l/s/ha then limiting discharge rates are set at 2.0 l/s/ha.

## Soil characteristics

	Default	Edited
SOIL type:	2	2
HOST class:	N/A	N/A
SPR/SPRHOST:	0.3	0.3

(2) Are flow rates  $< 5.0$  l/s?

Where flow rates are less than 5.0 l/s consent for discharge is usually set at 5.0 l/s if blockage from vegetation and other materials is possible. Lower consent flow rates may be set where the blockage risk is addressed by using appropriate drainage elements.

## Hydrological characteristics

	Default	Edited
SAAR (mm):	928	928
Hydrological region:	12	12
Growth curve factor 1 year:	0.85	0.85
Growth curve factor 30 years:	2.13	2.13
Growth curve factor 100 years:	2.61	2.61
Growth curve factor 200 years:	2.86	3.5

(3) Is  $SPR/SPRHOST \leq 0.3$ ?

Where groundwater levels are low enough the use of soakaways to avoid discharge offsite would normally be preferred for disposal of surface water runoff.

## Greenfield runoff rates

Default Edited

Q <sub>BAR</sub> (l/s):	241.12	241.12
1 in 1 year (l/s):	204.95	204.95
1 in 30 years (l/s):	513.59	513.59
1 in 100 year (l/s):	629.32	629.32
1 in 200 years (l/s):	689.6	843.92

This report was produced using the greenfield runoff tool developed by HR Wallingford and available at [www.uksuds.com](http://www.uksuds.com). The use of this tool is subject to the UK SuDS terms and conditions and licence agreement, which can both be found at [www.uksuds.com/terms-and-conditions.htm](http://www.uksuds.com/terms-and-conditions.htm). The outputs from this tool are estimates of greenfield runoff rates. The use of these results is the responsibility of the users of this tool. No liability will be accepted by HR Wallingford, the Environment Agency, CEH, Hydrosolutions or any other organisation for the use of this data in the design or operational characteristics of any drainage scheme.

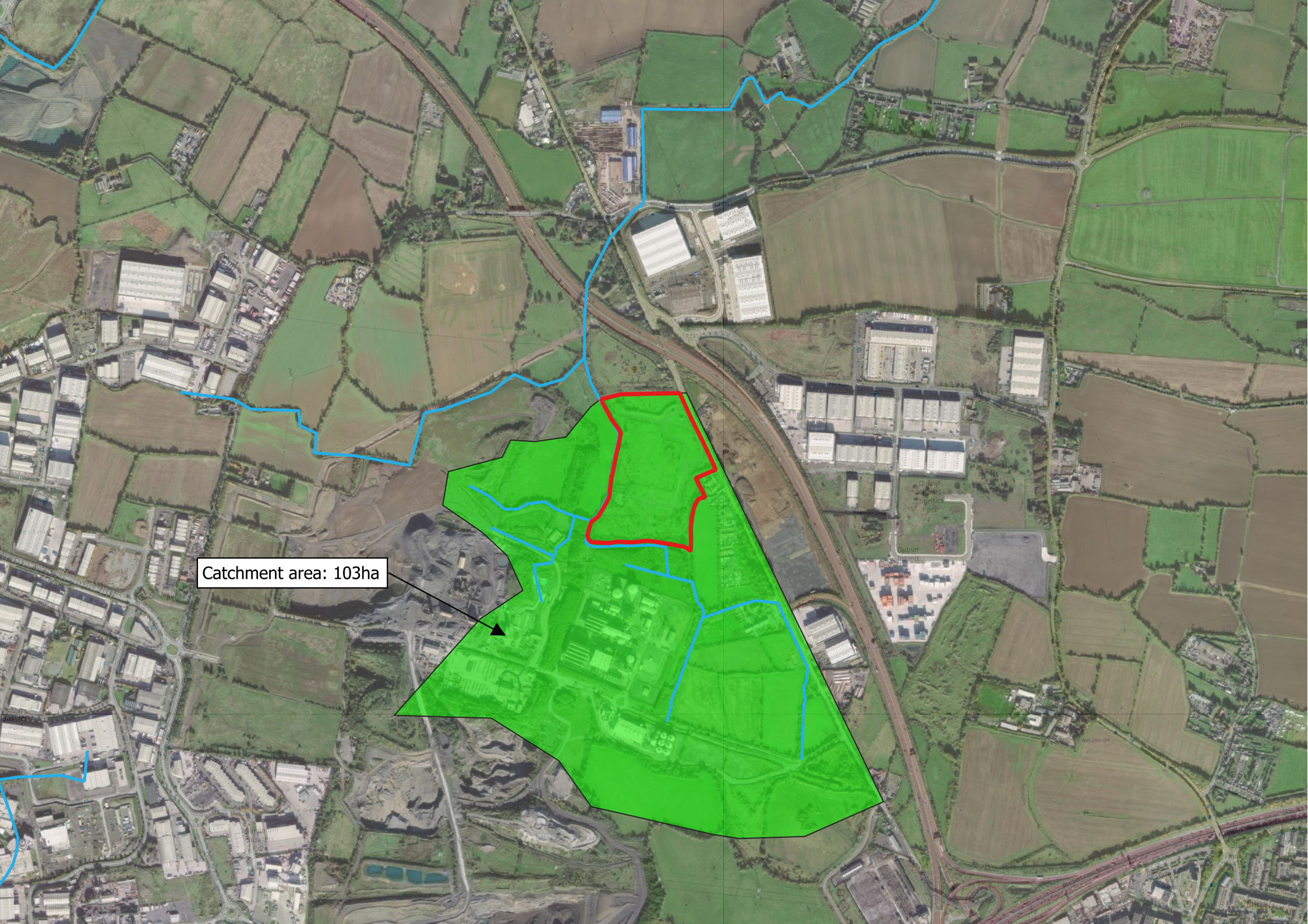

Catchment area: 103ha